

CONTENTS

ACURA / HONDA	1
AUDI / SEAT / SKODA / VOLKSWAGEN	2
BMW	3
CHRYSLER	4
CITROEN	5
DAEWOO	6
DAIHATSU	7
FIAT	8
FORD	9
GM	10
HOLDEN	11
HYUNDAI	12
INFINITI / NISSAN	13
ISUZU	14
JAGUAR	15
KIA	16
LAND ROVER	17
MAZDA	18
MERCEDES-BENZ	20
MINI	22
MITSUBISHI	23
OPEL / VAUXHALL	24
PERODUA	25
PEUGEOT	26
PORSCHE	27
PROTON	28
RENAULT	29
SAAB	30
SMART	31
SSANGYONG	32
SUBARU	33
SUZUKI	34
TOYOTA / LEXUS	35
VOLVO	36
OBDII (Available Vehicles)	37
TRUCK(Optional)	38

· Not every connectors are included in the standard package.
· 並非所有車種接頭都包含在標準配備內，依實際購買內容而定。

For ACURA / HONDA

OBD II Diagnostic Connector

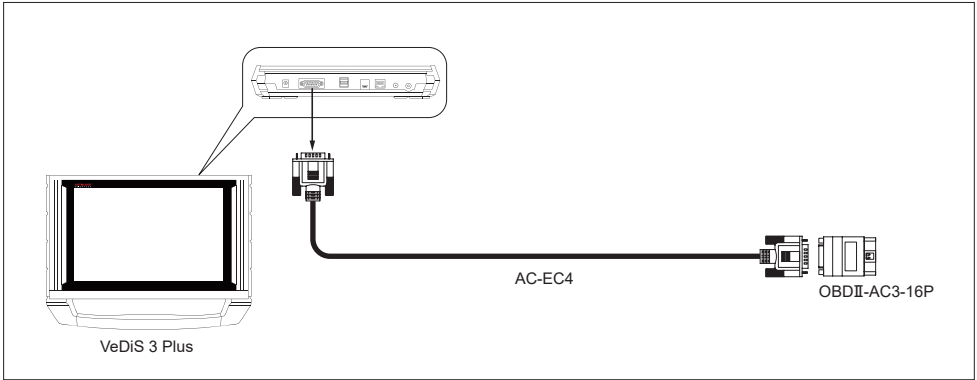

For ACURA / HONDA

2-Pin Diagnostic Connector

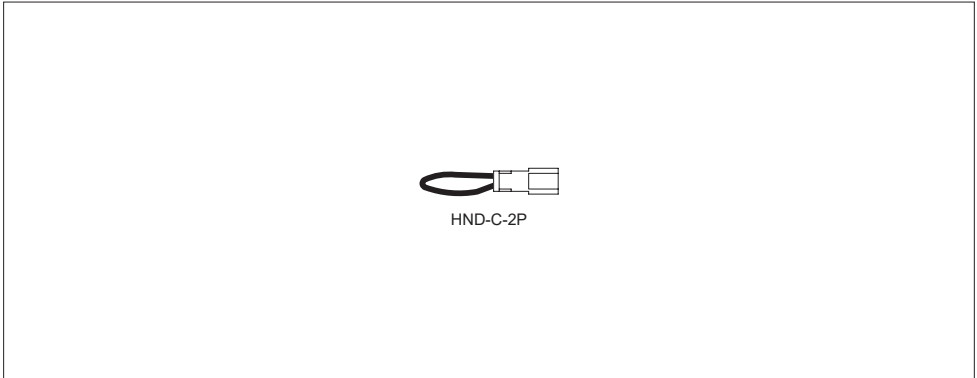

For ACURA / HONDA

3-Pin Diagnostic Connector

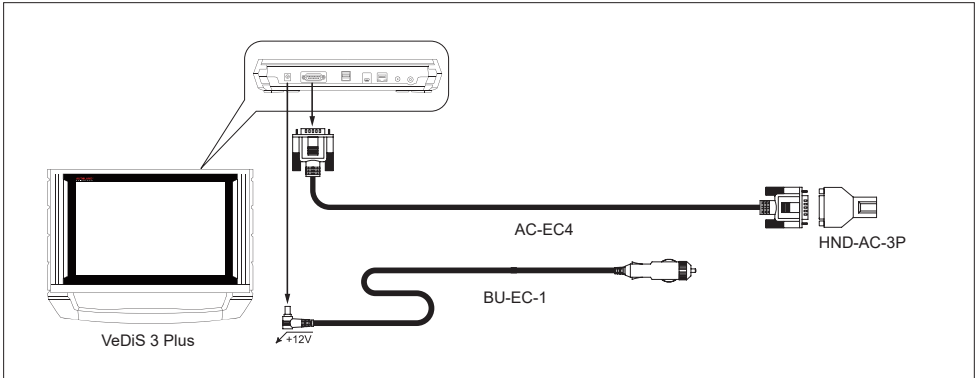

A

For AUDI / SEAT / SKODA / VOLKSWAGEN

OBD II Diagnostic Connector

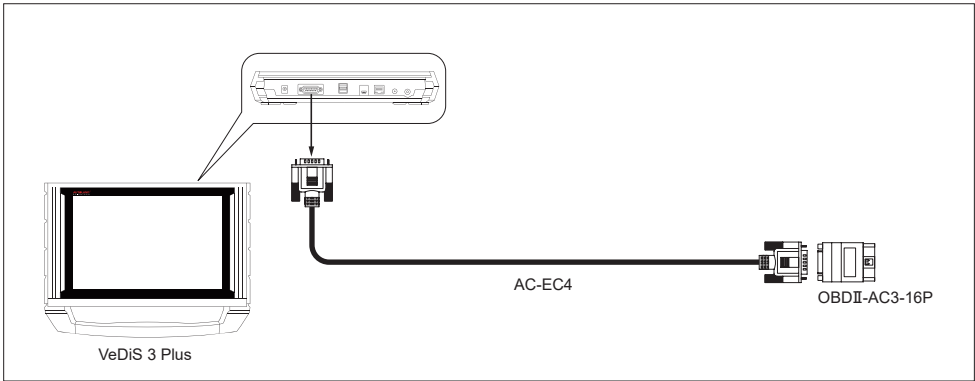

For AUDI / SEAT / SKODA / VOLKSWAGEN

VASS Diagnostic Connector

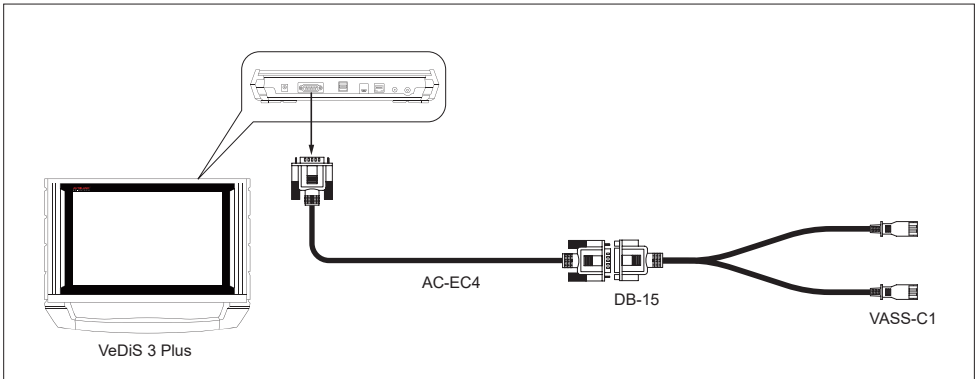

For BMW

OBD II Diagnostic Connector

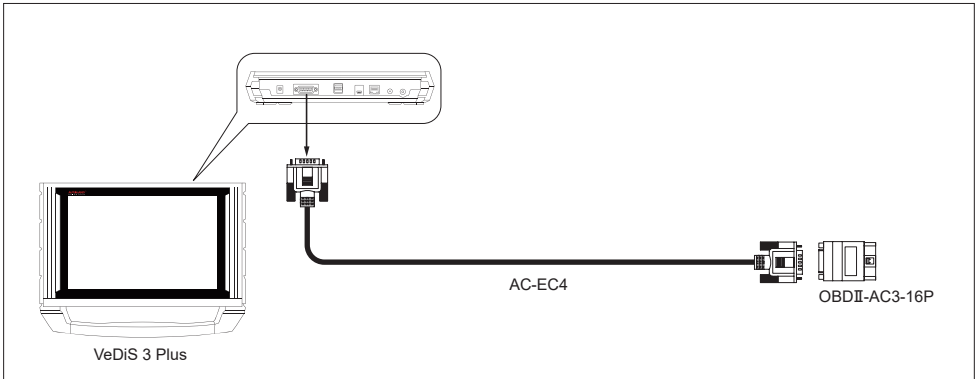

B

For BMW

20-Pin Diagnostic Connector

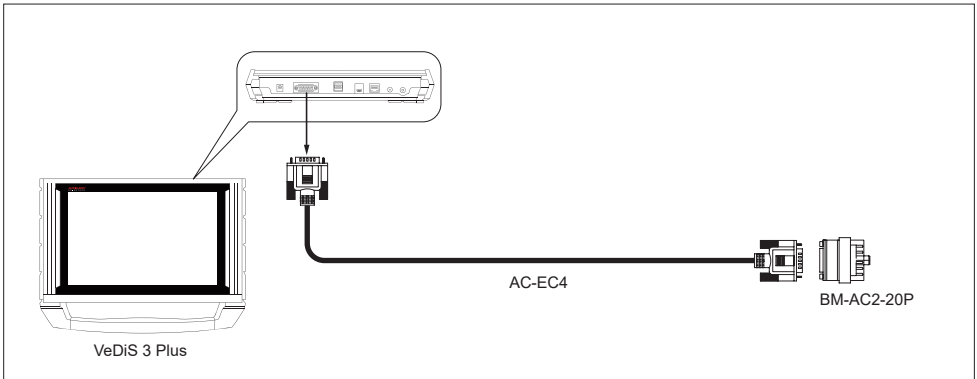

C

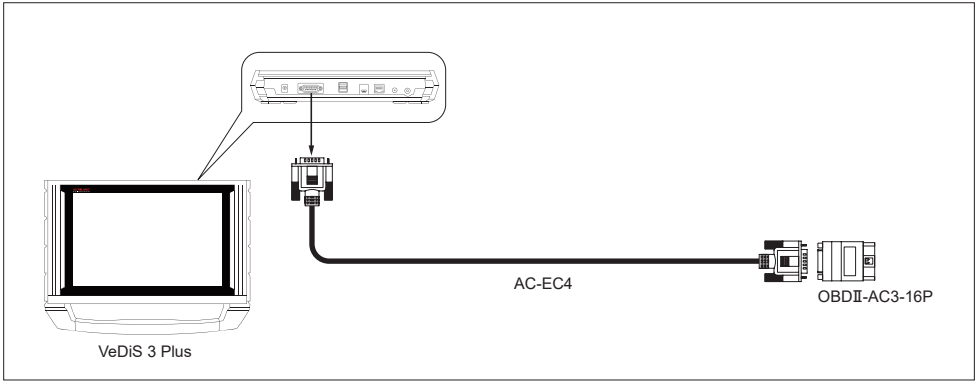

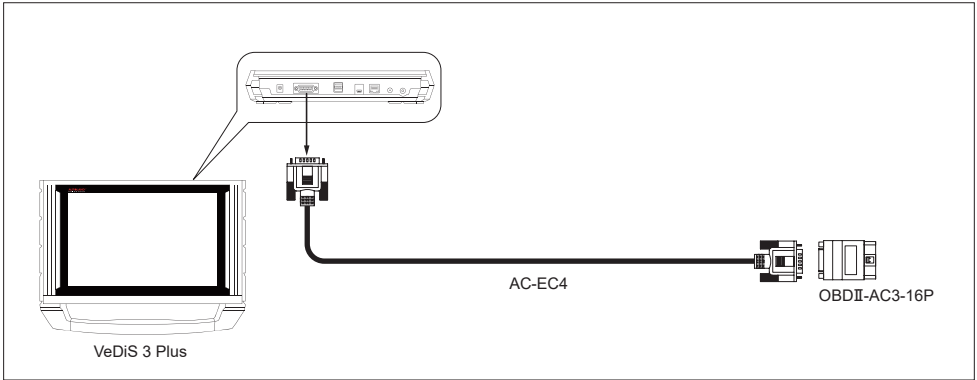

C

For DAEWOO

OBD II Diagnostic Connector

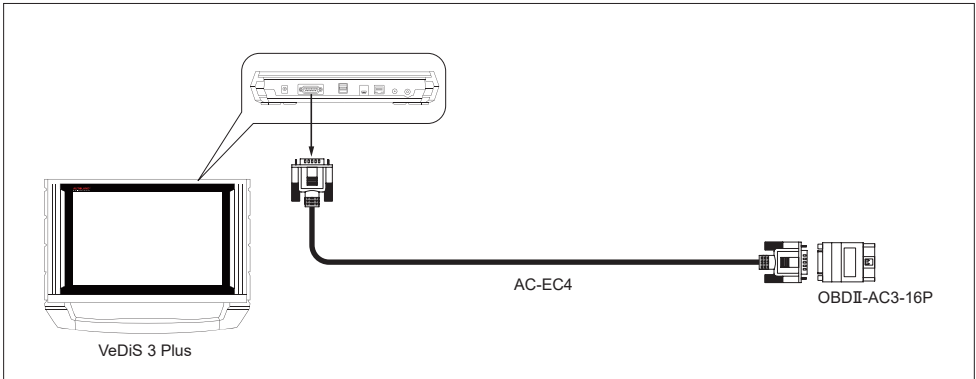

For DAEWOO

12-Pin Diagnostic Connector

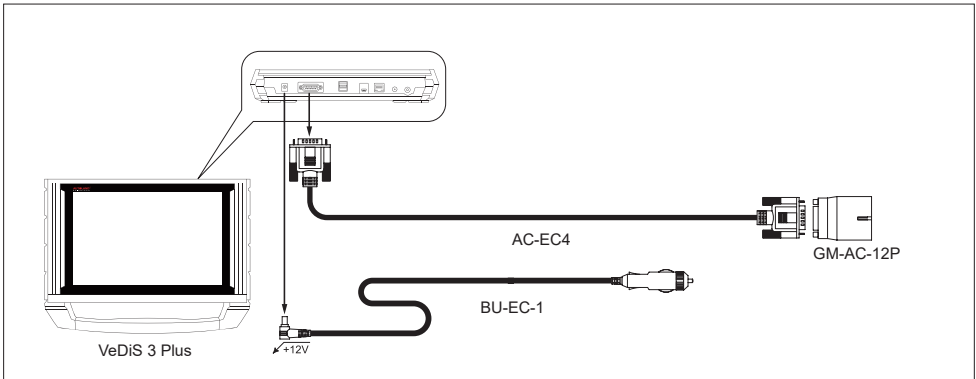

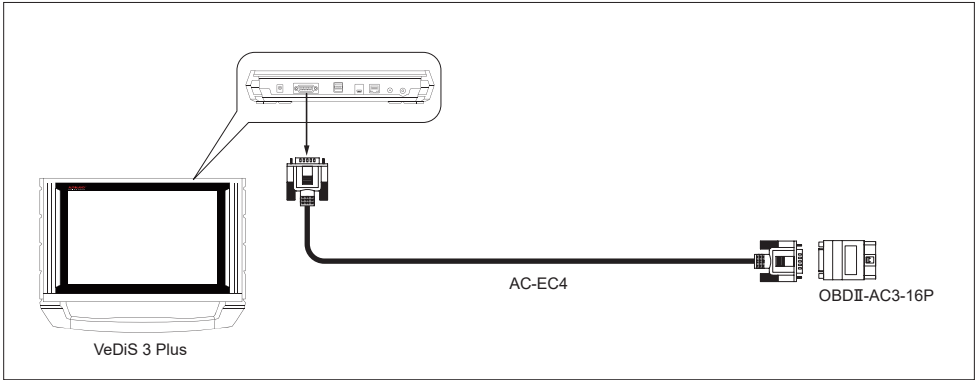

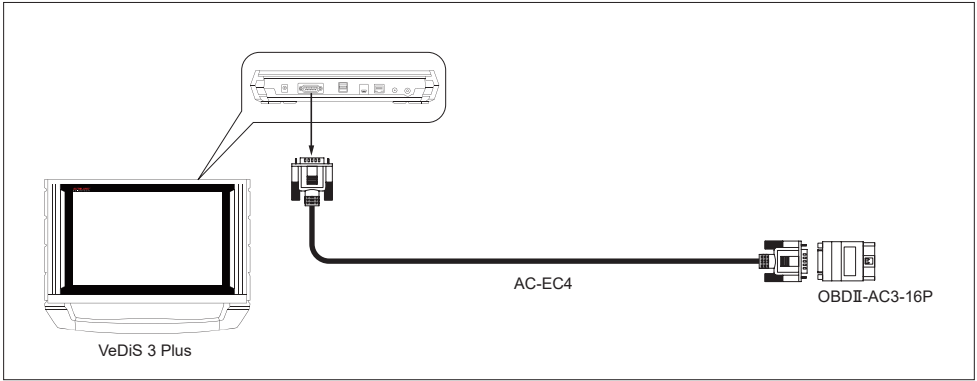

F

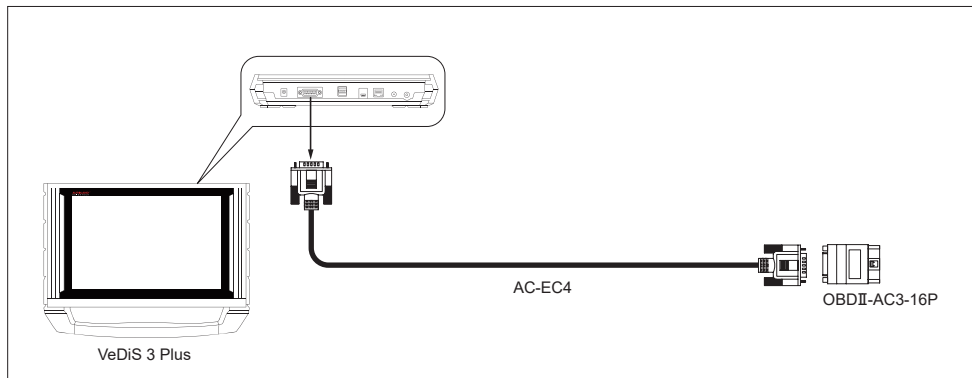

- Note: 1. For the models ACTIVA, TIERRA, LIATA and MAV: please refer to page 18 Mazda connector.
 2. For the model of PRONTO: please refer to page 34 Suzuki connector.
 3. For model FESTIVA, please refer to the 20-Pin adapter connection on page 16 as KIA's.

- 附註：1. ACTIVE TIERRA LIATA MAV 車型：請參考第 18 頁的 Mazda 接法。
 2. PRONTO 車型，請參考第 34 頁 Suzuki 接法。
 3. FESTIVA 車型，請參考第 16 頁 KIA，20Pin 接法。



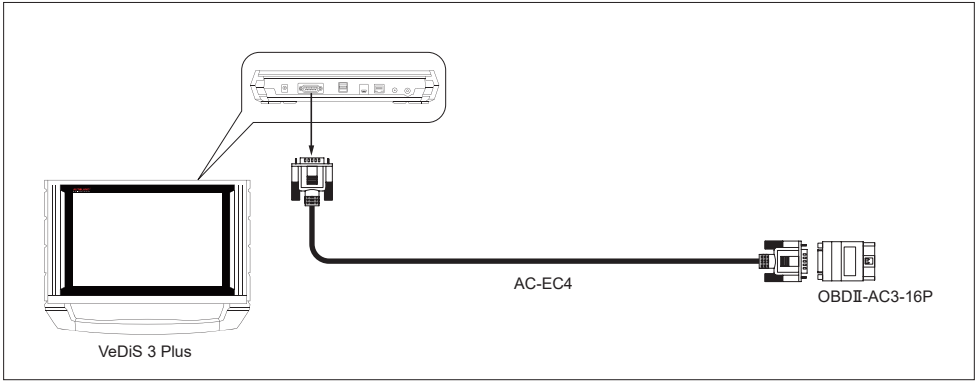

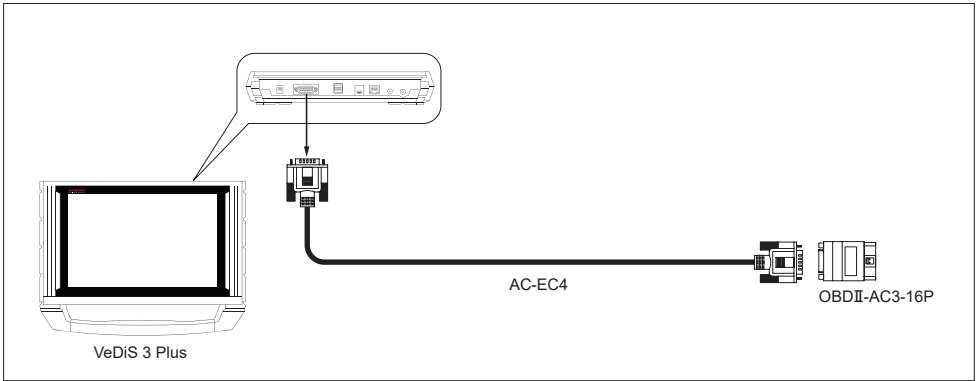

For HYUNDAI

OBD II Diagnostic Connector

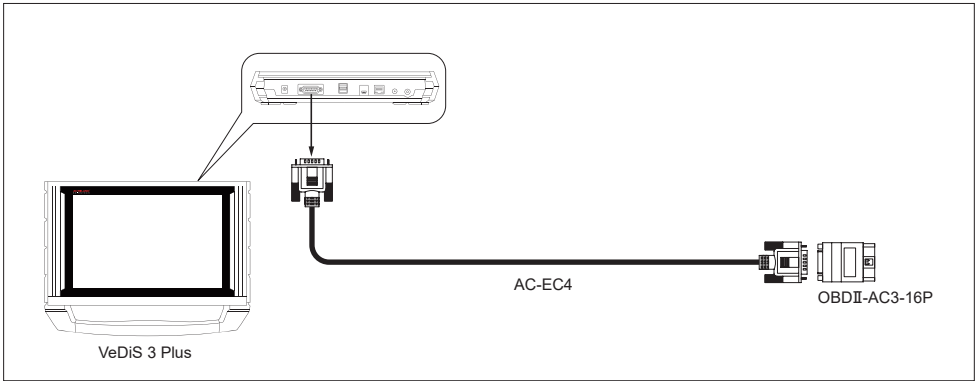

H

For HYUNDAI

12-Pin Diagnostic Connector

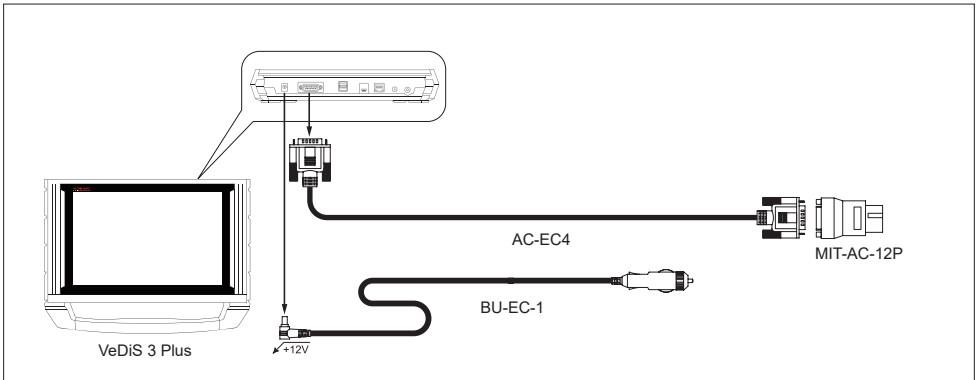

For INFINITI / NISSAN

OBD II Diagnostic Connector

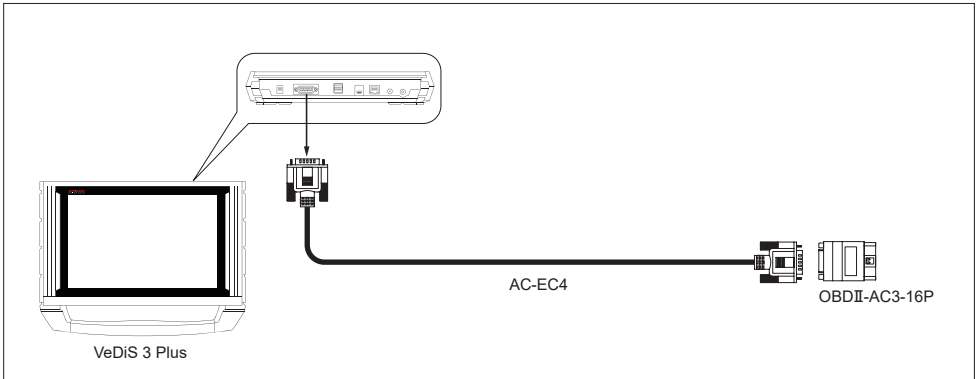

For INFINITI / NISSAN

14-Pin Diagnostic Connector

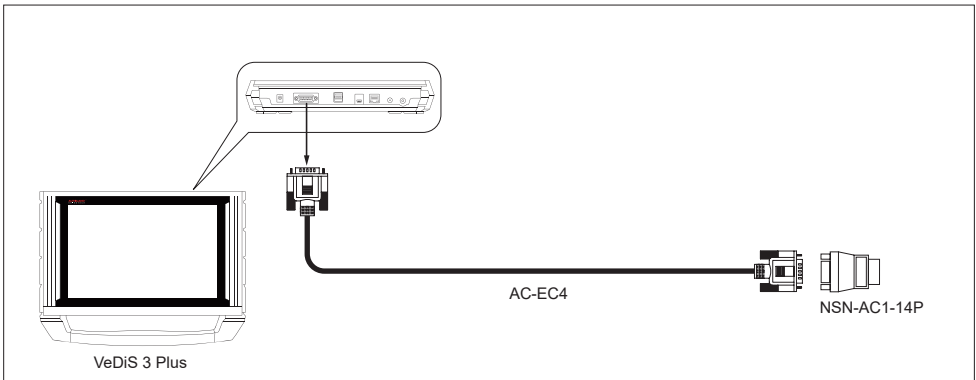

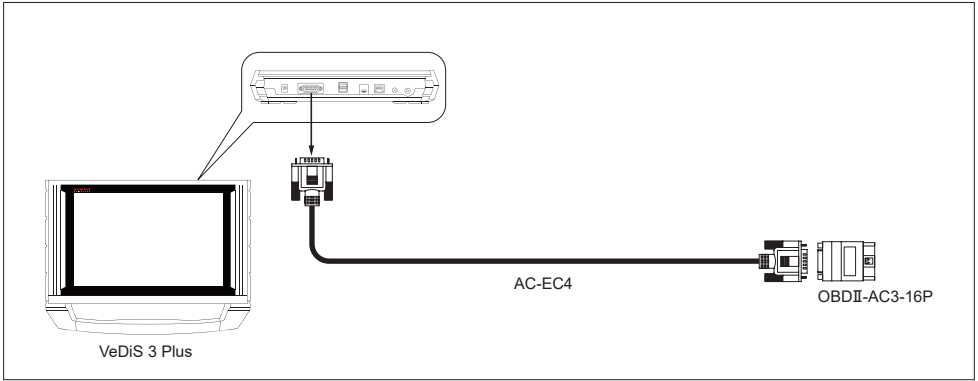

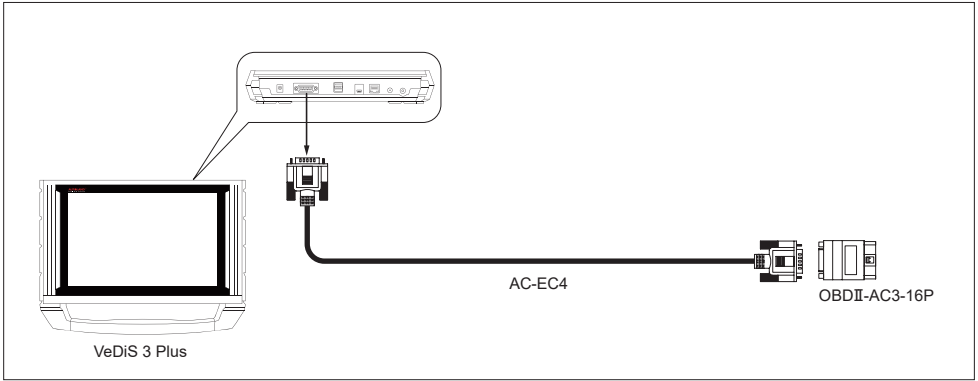

For KIA

OBD II Diagnostic Connector

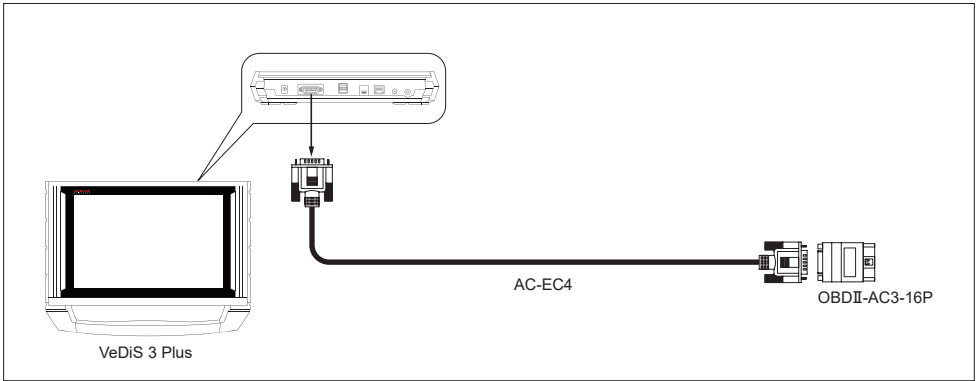

For KIA

20-Pin Diagnostic Connector

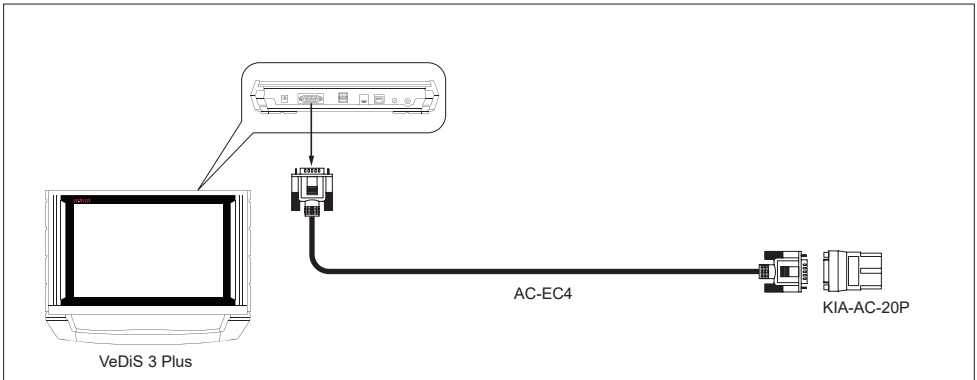

K

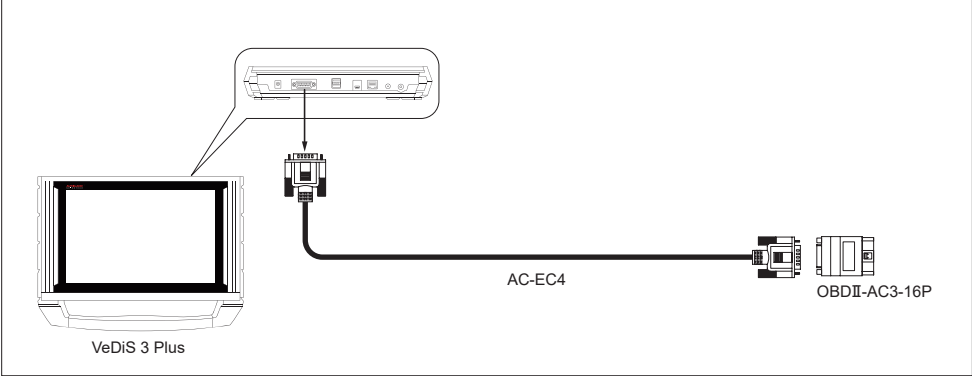

For MAZDA

OBD II Diagnostic Connector

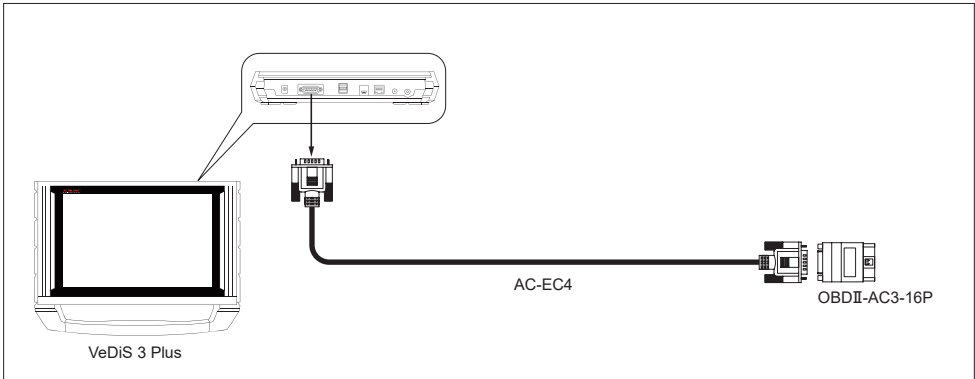

Note: 1. Apply to Mazda models equipped with OBD- II connector, year 2003~only.

附註：1. 僅限2003年以後Mazda配備OBD-II診斷接頭之車種。

For MAZDA

Mazda Diagnostic Connector (UC-1MMV)

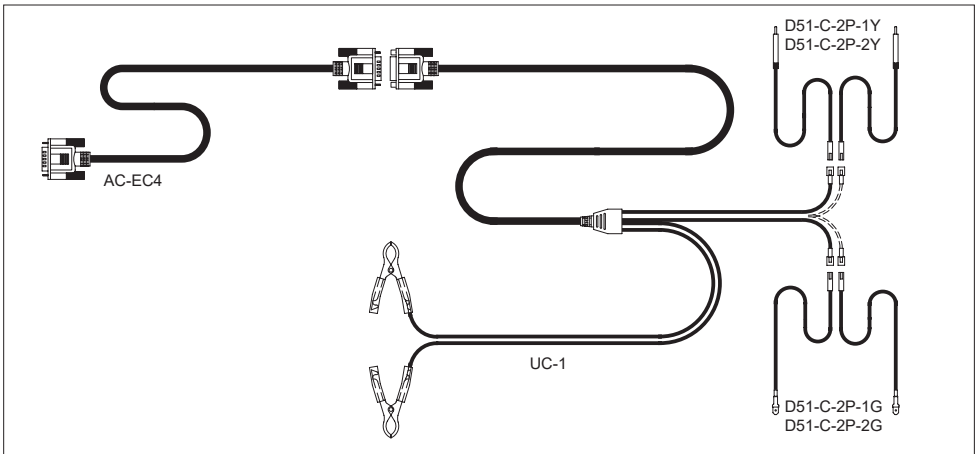

M

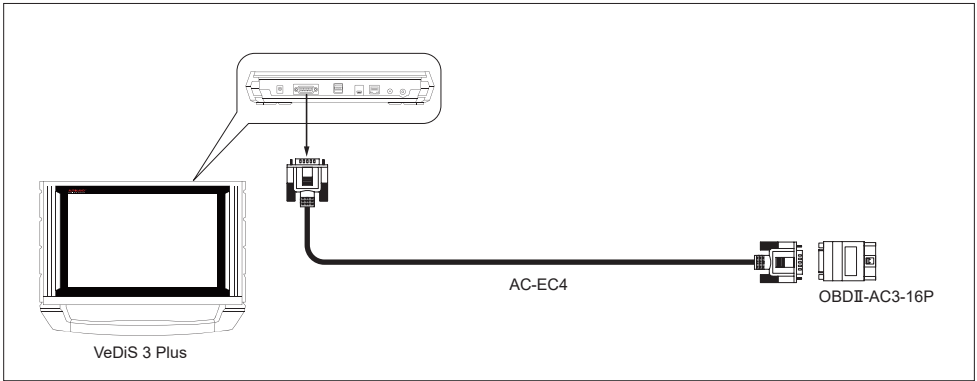

For MERCEDES BENZ

OBD II Diagnostic Connector

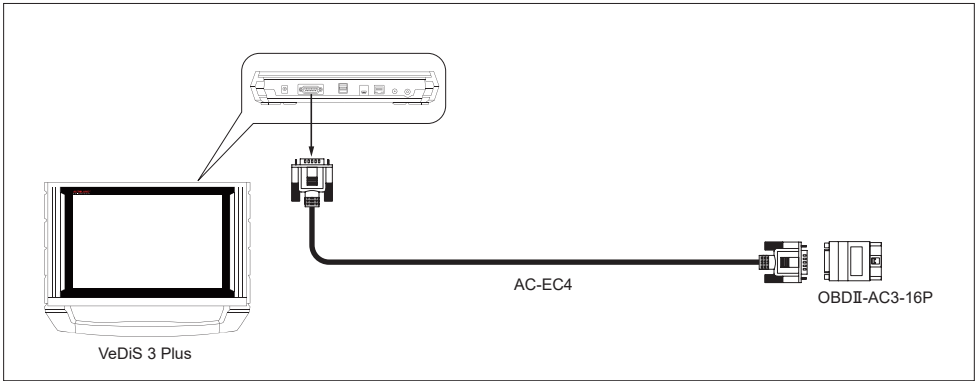

For MERCEDES BENZ

8/16-Pin Diagnostic Connector (UC-1MMV)

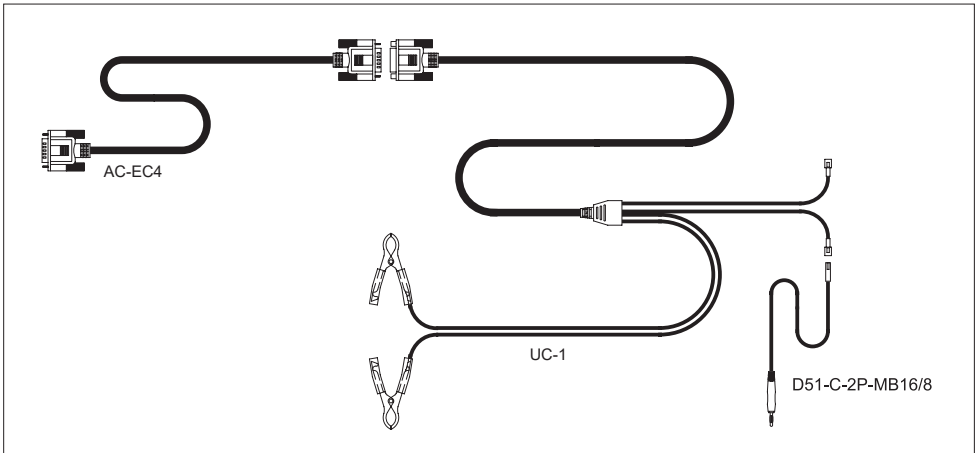

M

For MERCEDES BENZ

38-Pin Diagnostic Connector(Autoswitching Multiplexer)

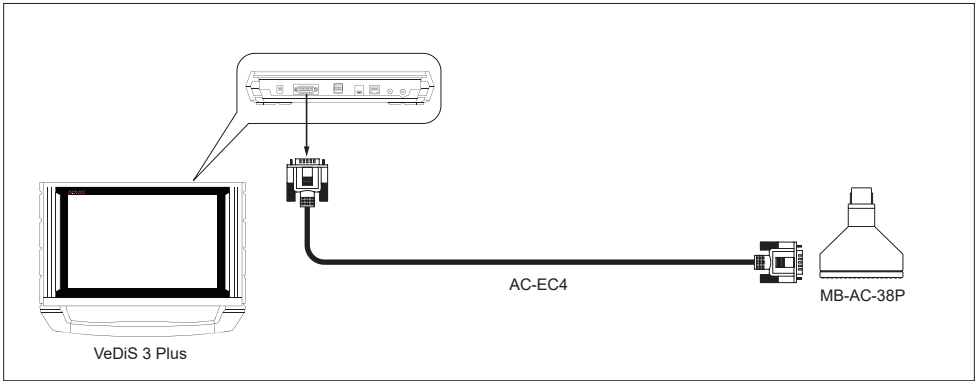

For MERCEDES BENZ

14-Pin Diagnostic Connector (Optional)

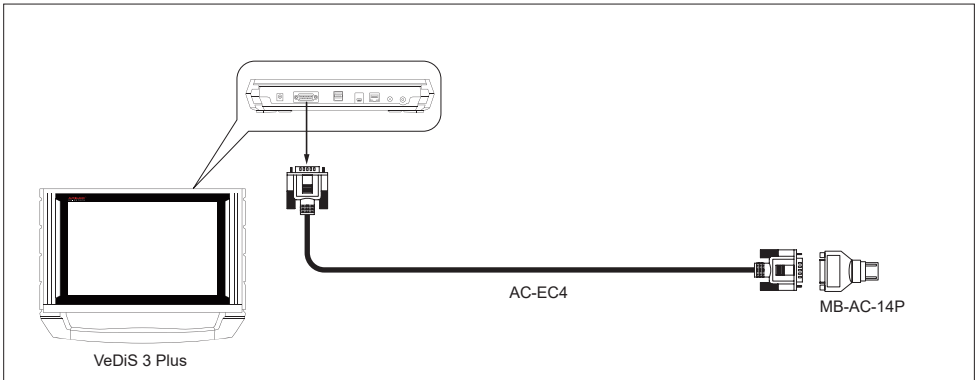

For MINI

OBD II Diagnostic Connector

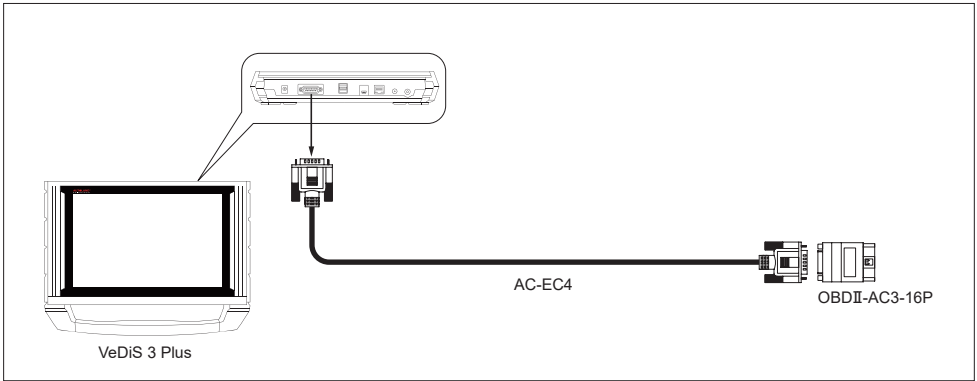

M

For MITSUBISHI

OBD II Diagnostic Connector

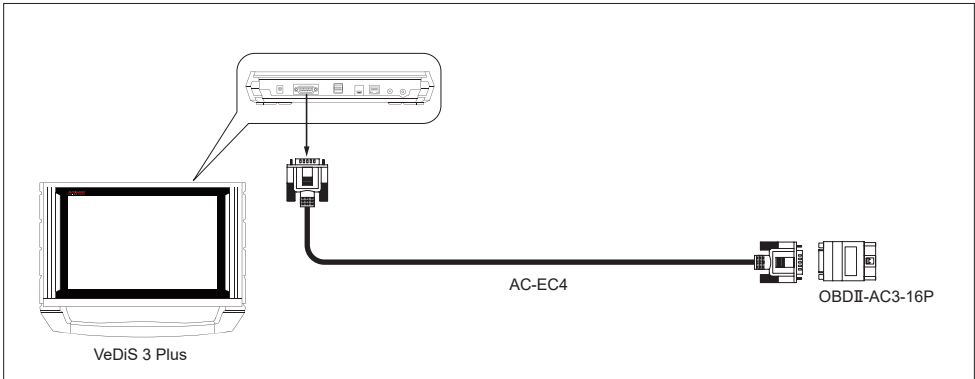

For MITSUBISHI

12-Pin Diagnostic Connector

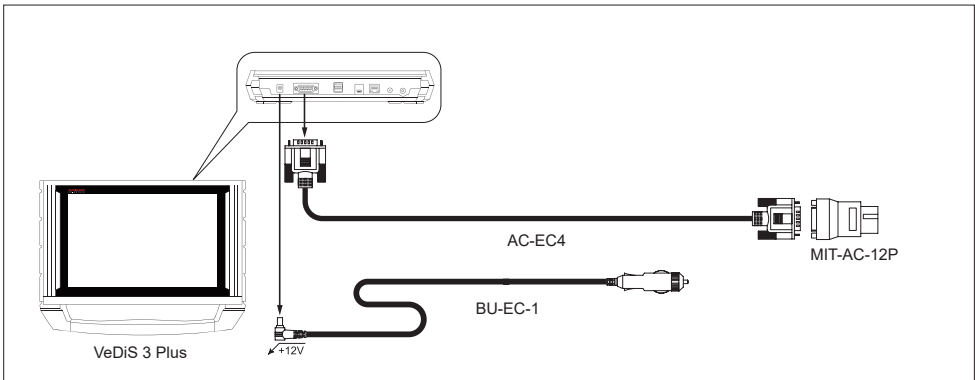

Note: 1. For the model of VARICA 1.2: please use CMC software equipped with AC-EC4 + GM-AC-12P

附註：1. VARICA 1.2車型：請用CMC軟體，AC-EC4 + GM-AC-12P

M

For OPEL / VAUXHALL

OBDD II Diagnostic Connector

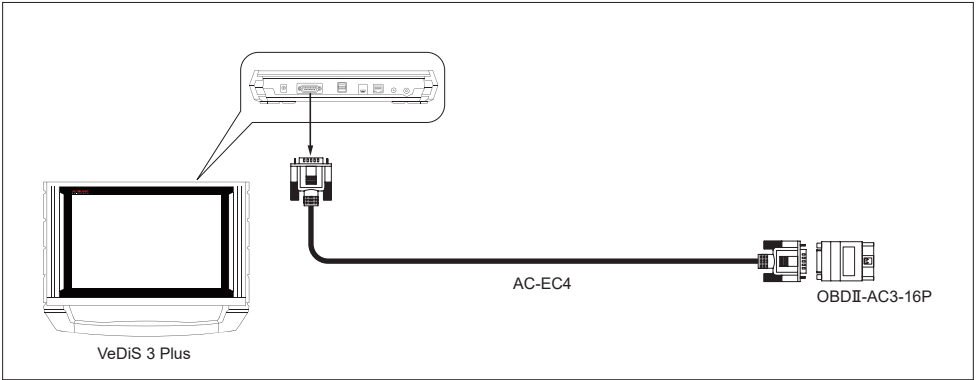

For OPEL / VAUXHALL

10-Pin Diagnostic Connector

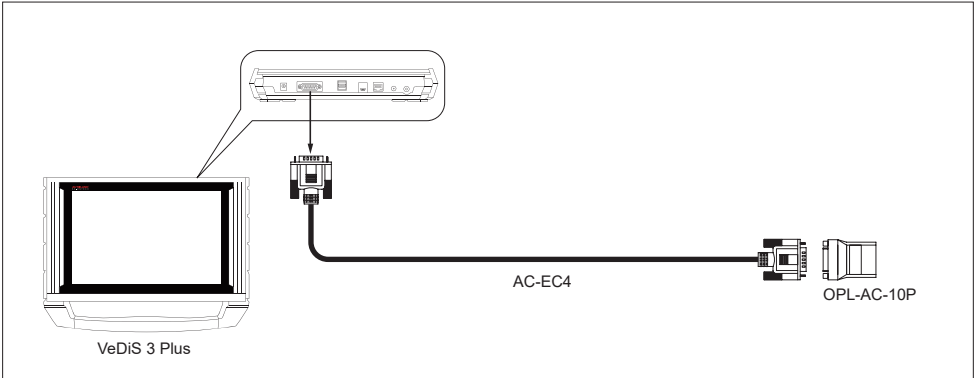

For OPEL / VAUXHALL

12-Pin Diagnostic Connector

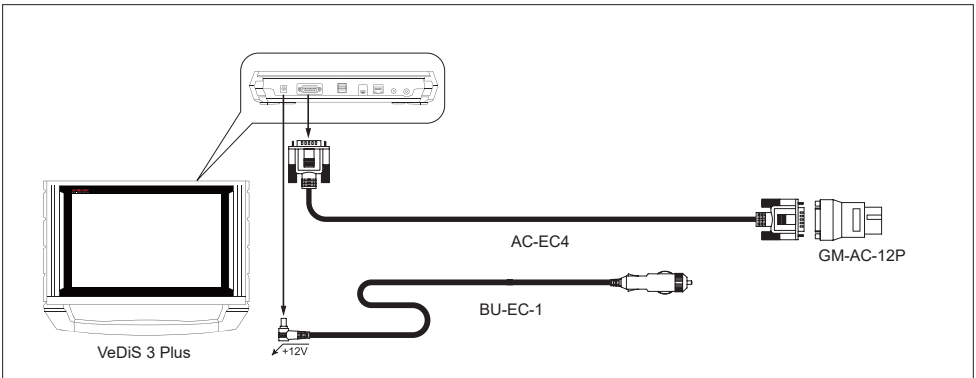

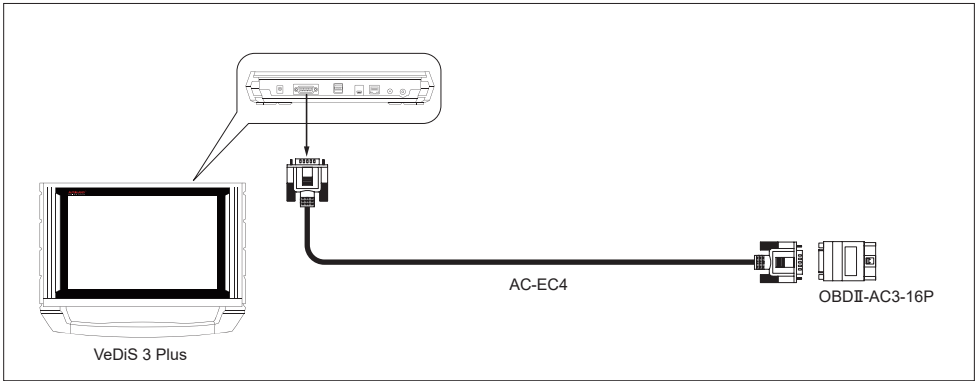

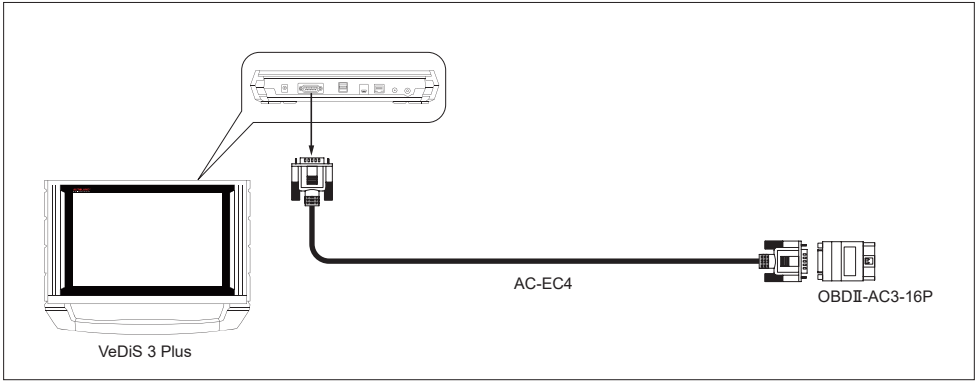

For PORSCHE

OBD II Diagnostic Connector

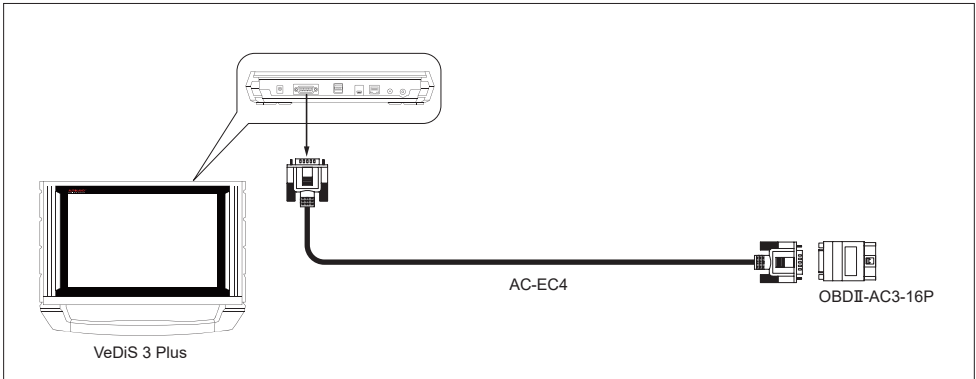

For PORSCHE

19-Pin Diagnostic Connector

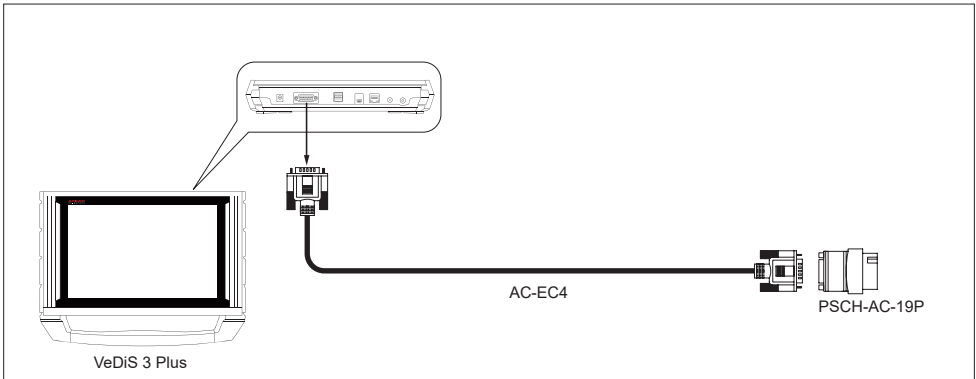

For PROTON

OBD II Diagnostic Connector

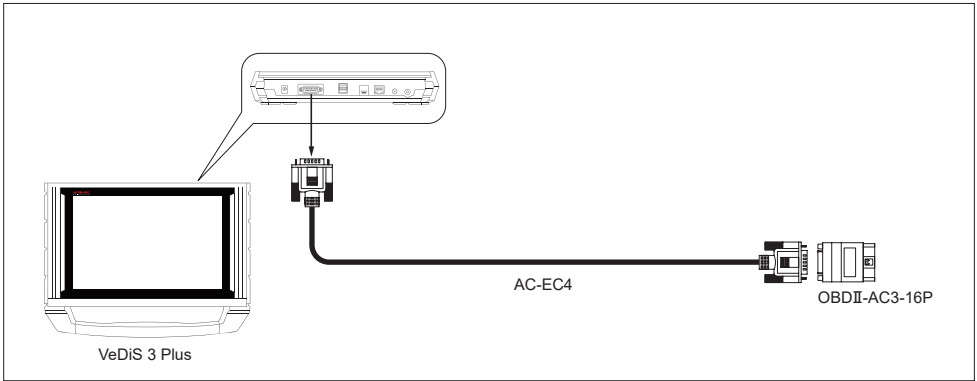

For PROTON

12-Pin Diagnostic Connector

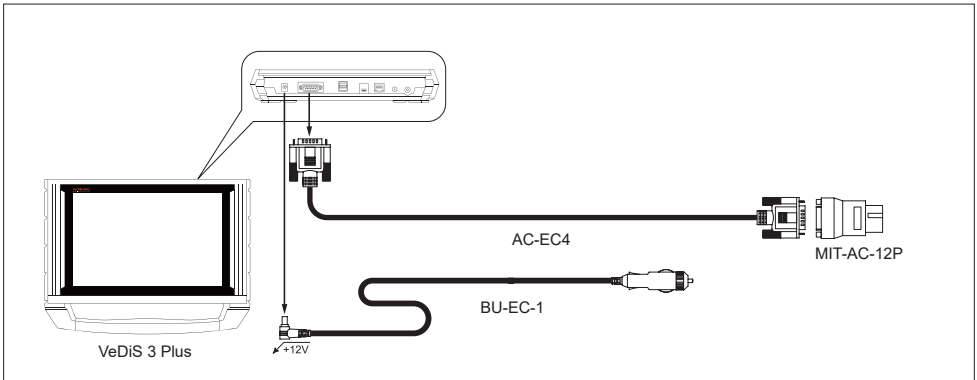

P

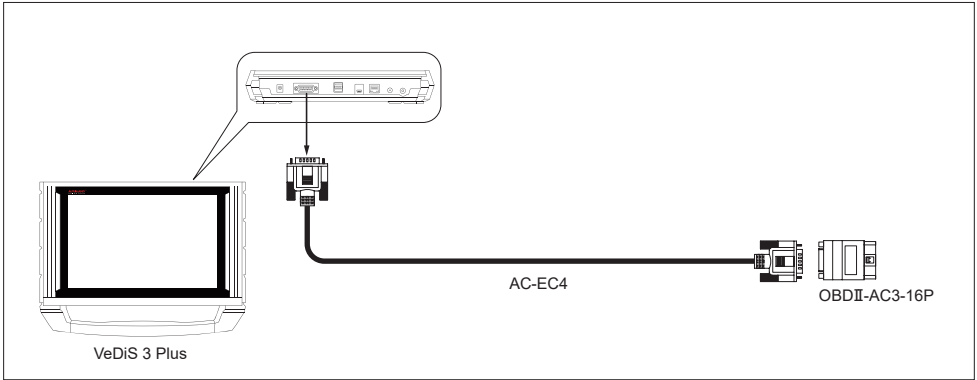

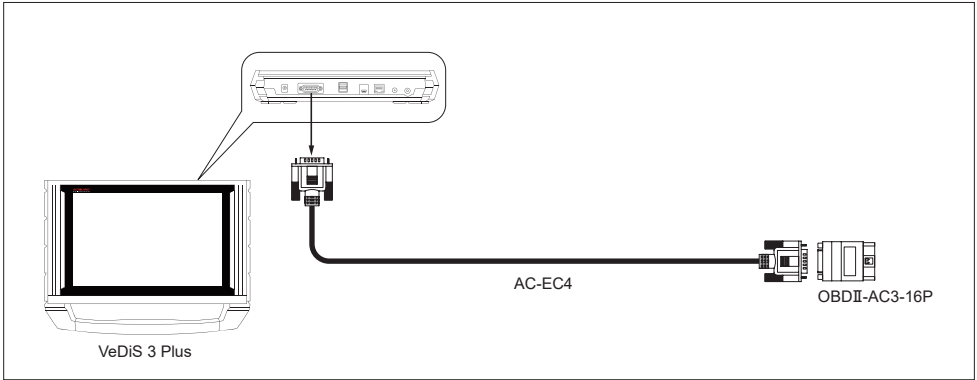

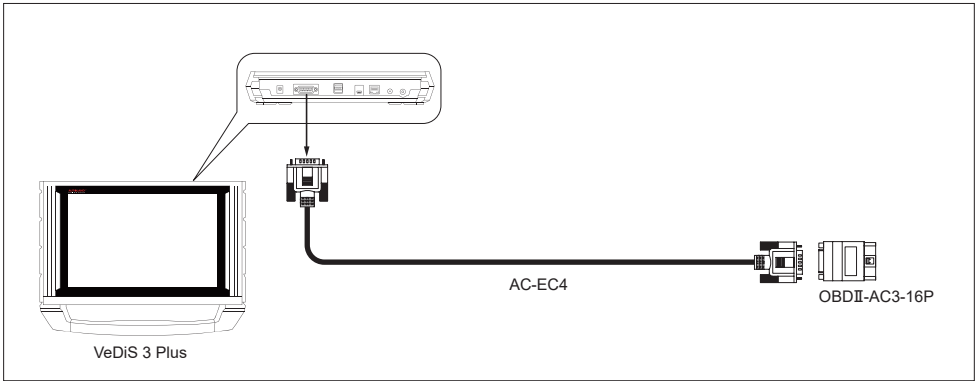

For SSANGYONG

OBD II Diagnostic Connector

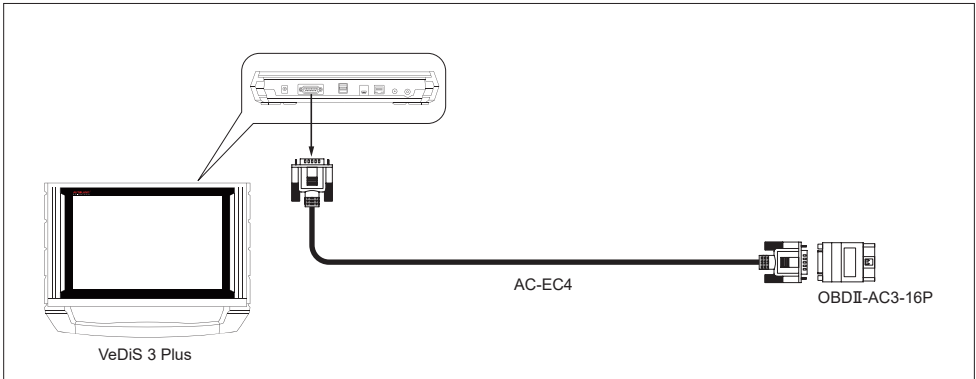

For SSANGYONG

14-Pin Diagnostic Connector (Optional)

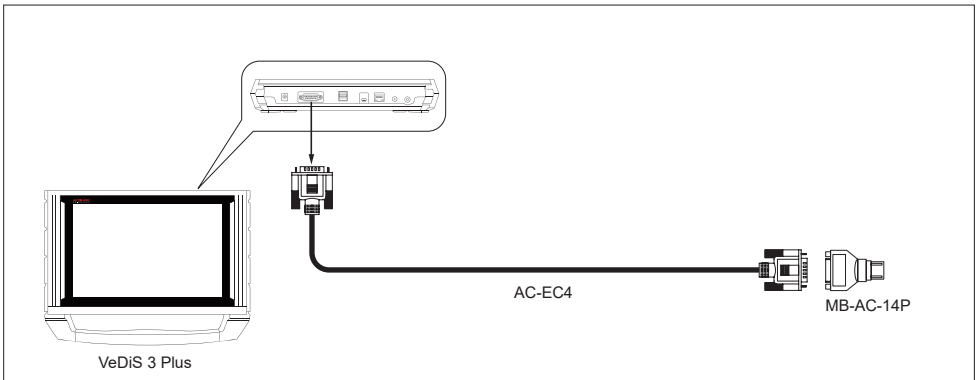

S

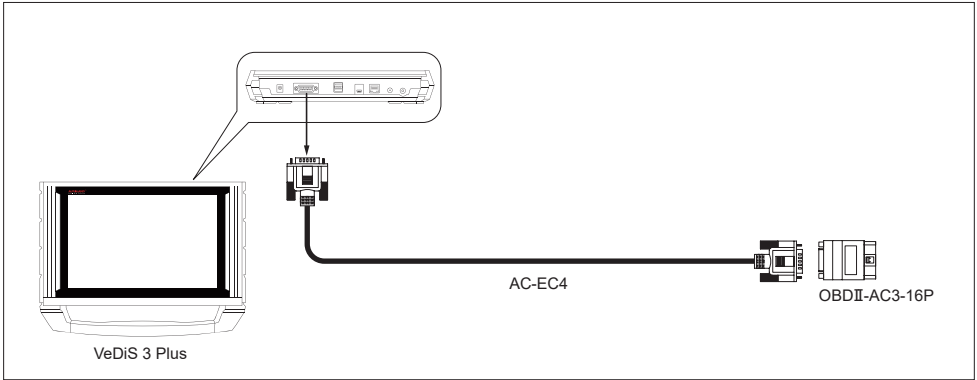

For SUZUKI

OBD II Diagnostic Connector

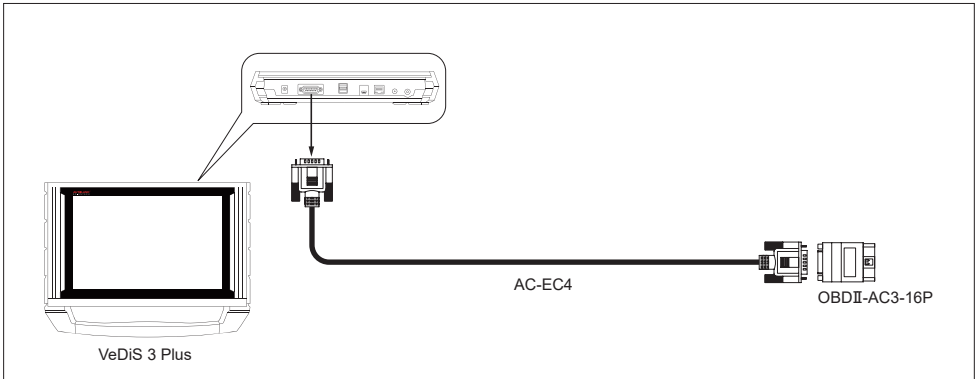

For SUZUKI

12-Pin Diagnostic Connector

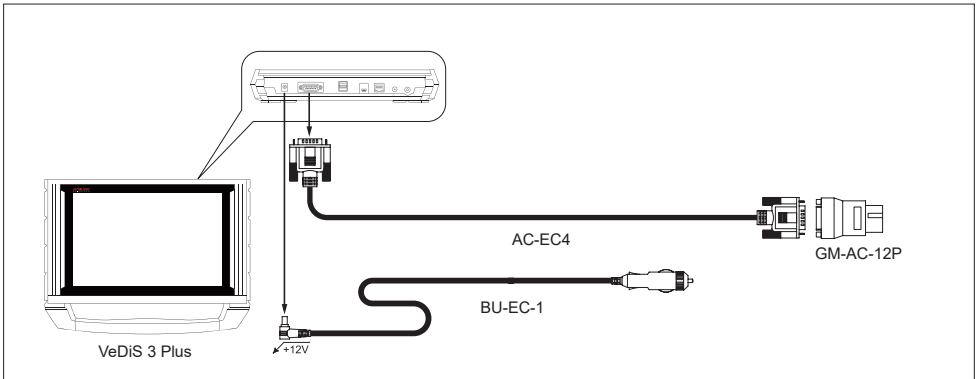

S

For TOYOTA / LEXUS

OBD II Diagnostic Connector

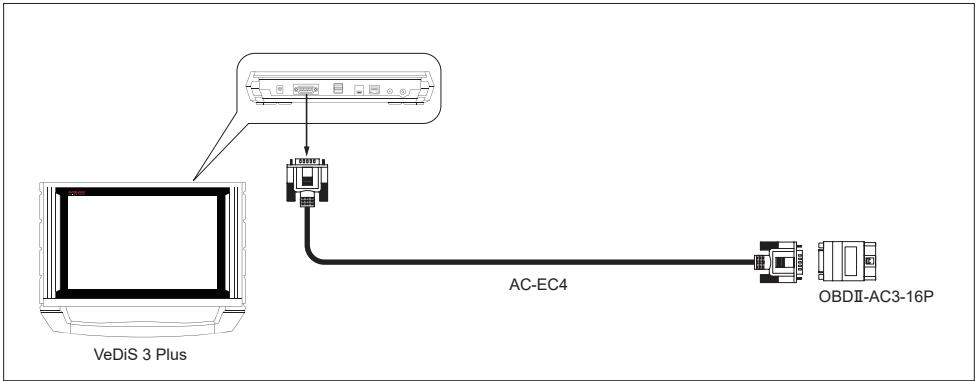

For TOYOTA / LEXUS

17-Pin Diagnostic Connector

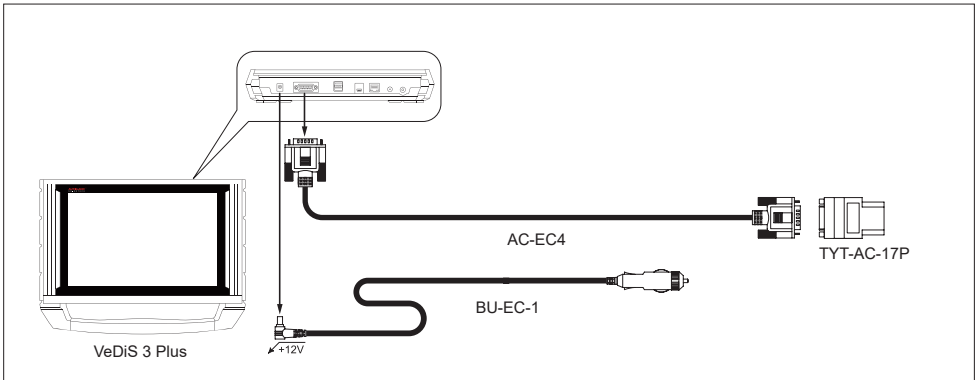

For TOYOTA / LEXUS

23-Pin Diagnostic Connector

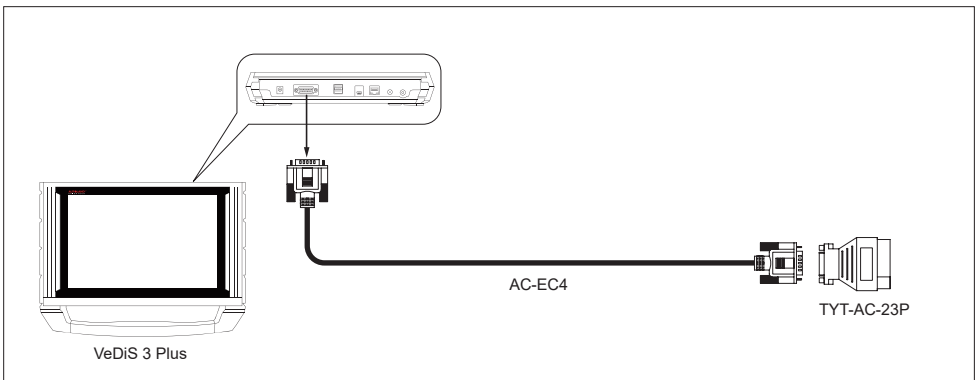

For VOLVO

OBD II Diagnostic Connector

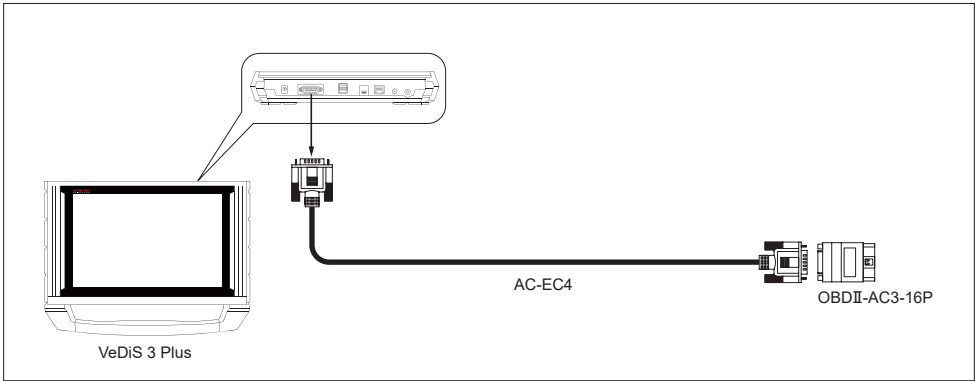

For VOLVO

A/B Diagnostic Connector (UC-1MMV)

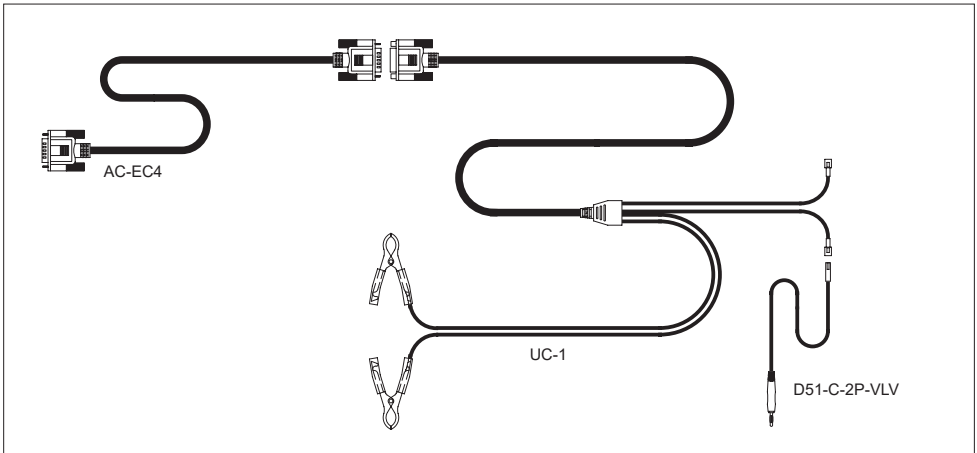

☆ **OBDII**

Available Vehicles :

European Vehicles	Asian Vehicles	US Vehicles
ALFA ROMEO AUDI BMW CITROEN FIAT JAGUAR LANCIA LAND ROVER MERCEDES-BENZ MINI OPEL/VAUXHALL PEUGEOT PORSCHE RENAULT ROLLS ROYCE ROVER SAAB SEAT SKODA VOLKSWAGEN VOLVO	ACURA DAEWOO DAIHATSU FORD HOLDEN HONDA HYUNDAI INFINITI ISUZU KIA LEXUS MAZDA MITSUBISHI NISSAN PROTON SSANGYONG SUBARU SUZUKI TOYOTA	BUICK CADILLAC CHEVROLET CHRYSLER FORD GMC HUMMER JEEP LINCOLN MERCURY OLDSMOBILE PONTIAC SATURN
		<p>Australia Vehicles</p> HOLDEN

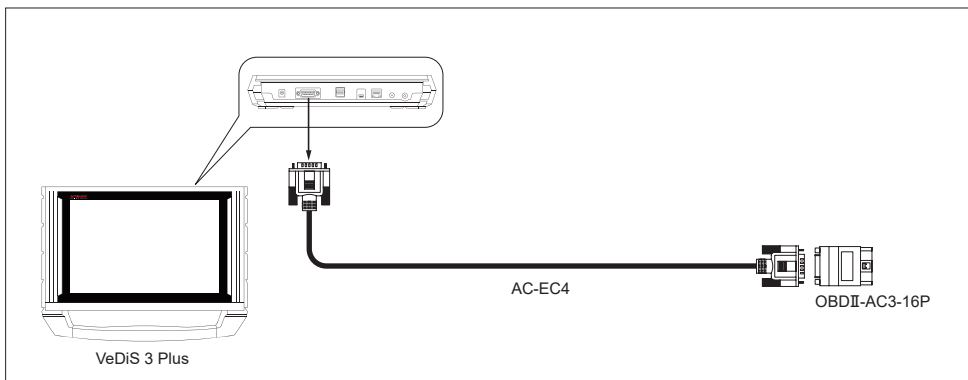

*Products referred to in this manual are mentioned for identification purposes only. Company's names and trademarks contained in this manual are registered by the respectively companies.

本手冊所提及之商標名，純粹為說明文件使用。圖文所提及之公司及商標均為各該公司所擁有。

Truck : HINO

OBD II Diagnostic Connector

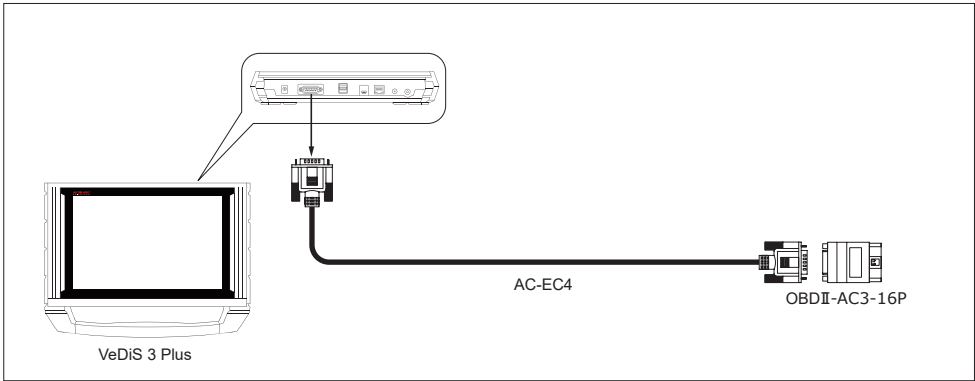

Truck : ISUZU (N Series)

OBD II Diagnostic Connector

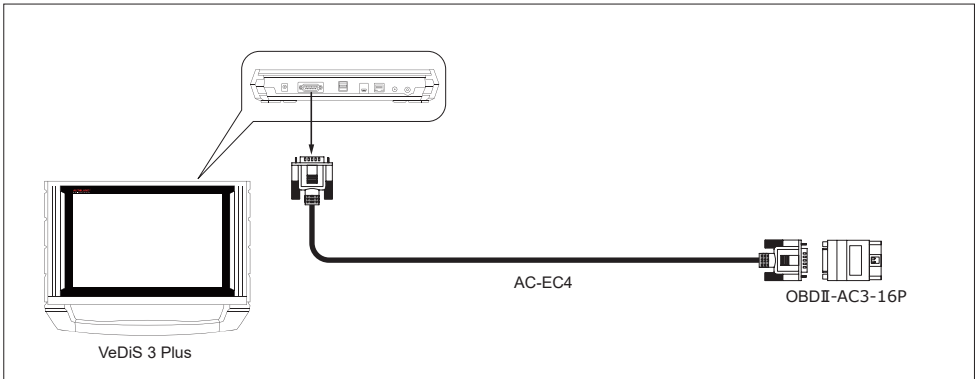

Truck : FUSO (Less than 3.5T)

OBD II Diagnostic Connector

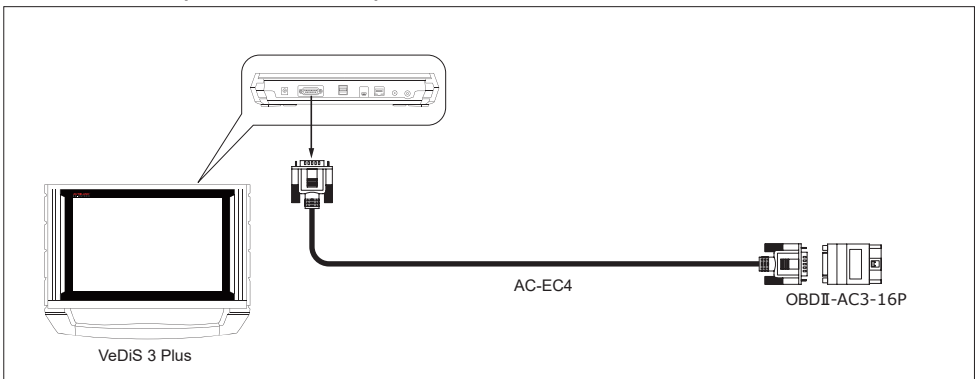

Truck : UD

OBD II Diagnostic Connector

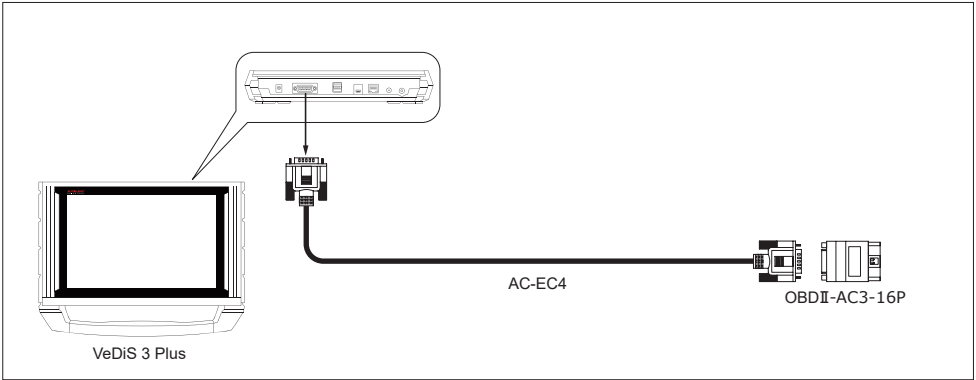

Truck : DYNA

OBD II Diagnostic Connector

